

Termoventiler AB

Laddomat 21

For accumulation when using a wood-fired boiler

Picture 1

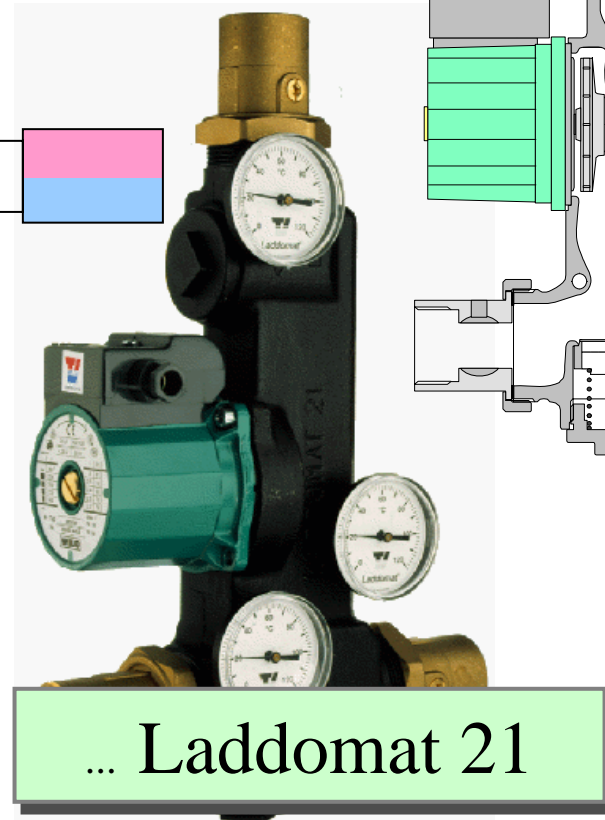
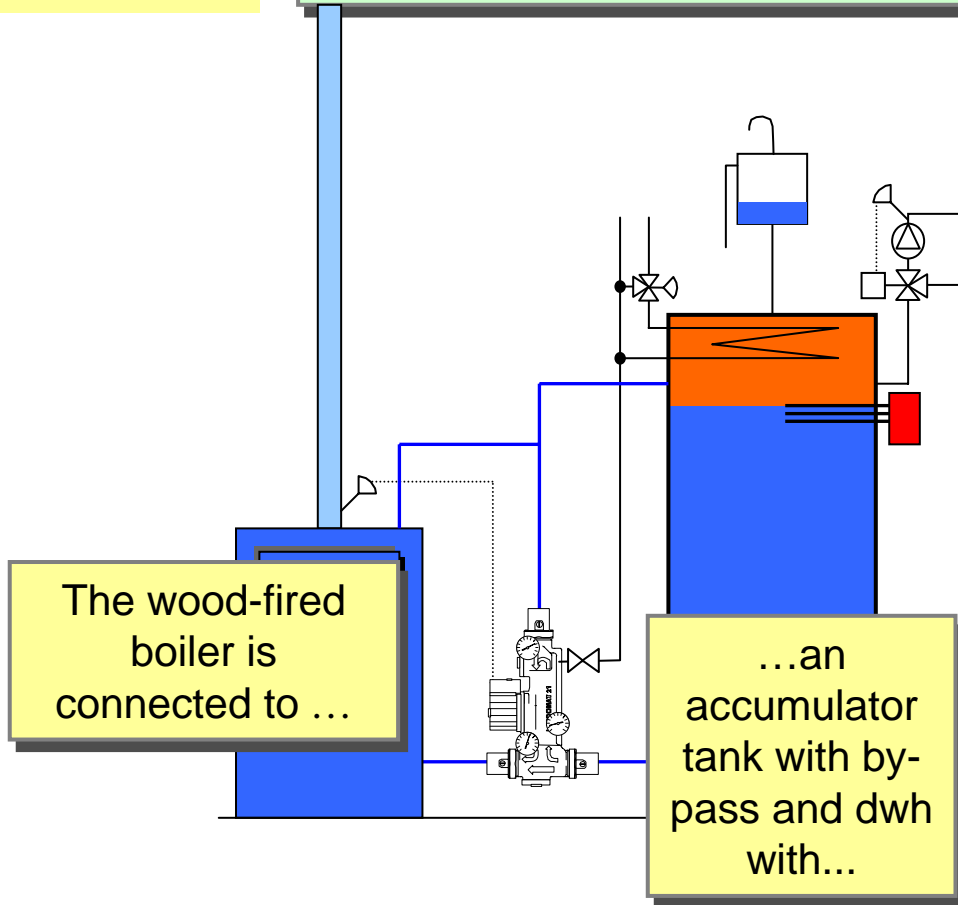

... Laddomat 21

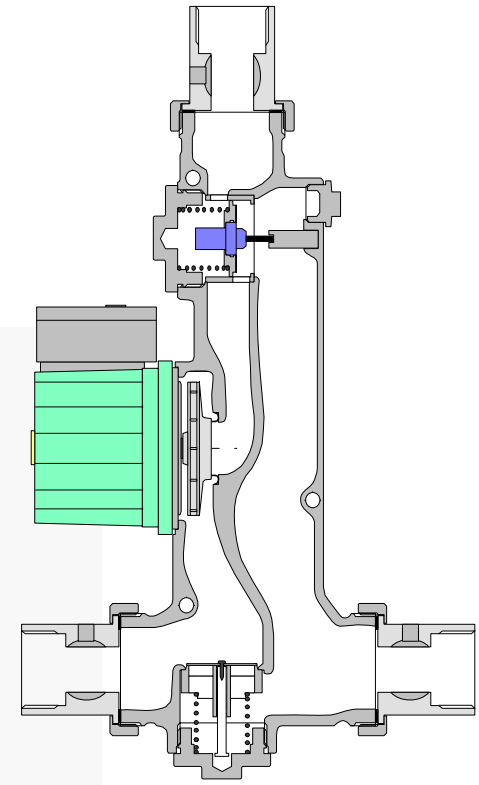

...and this is how it works...

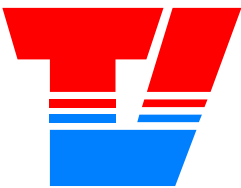

Termoventiler AB

Laddomat 21

Picture 2

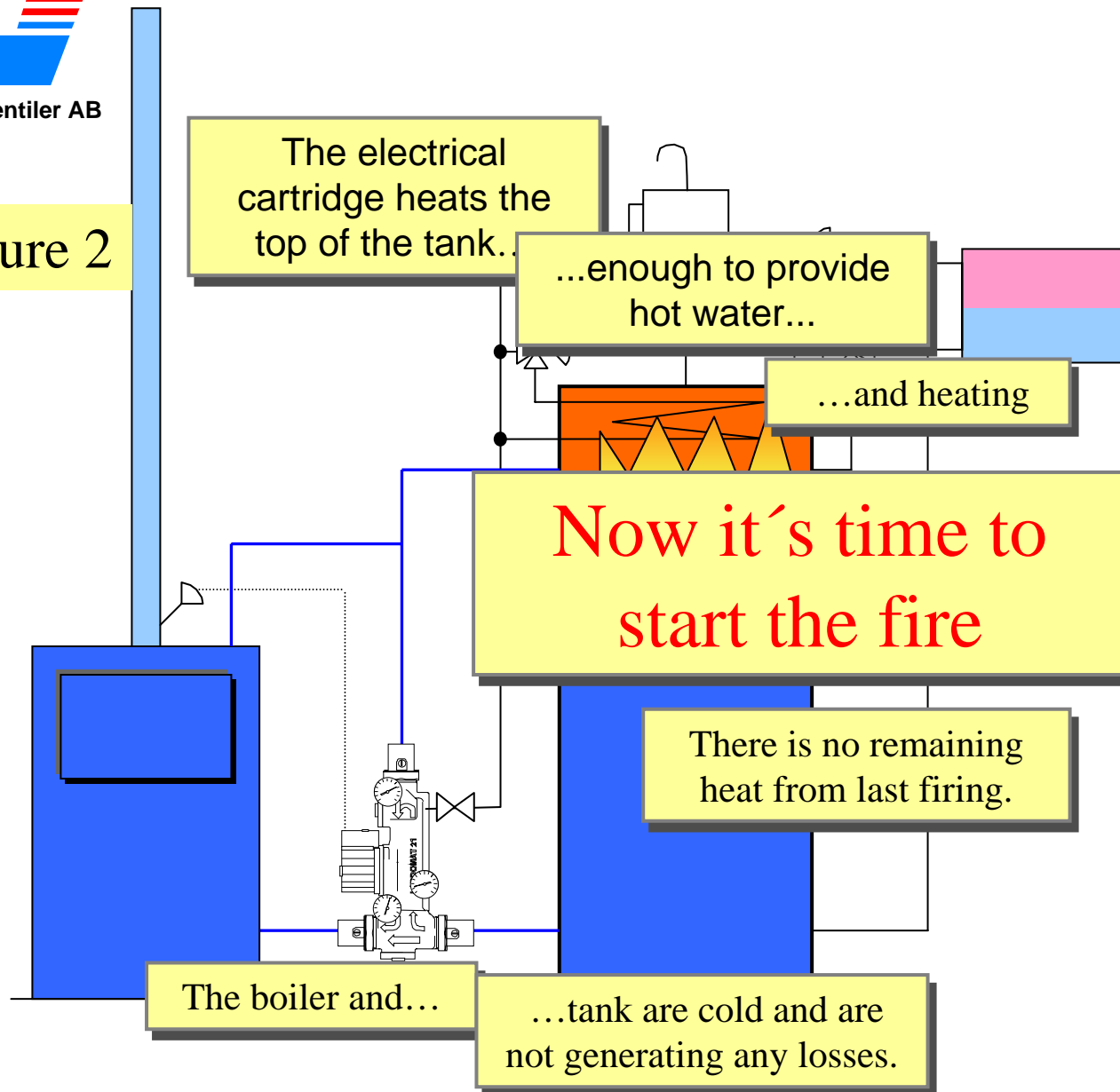

Laddomat 21



Termoventiler AB



Picture 3

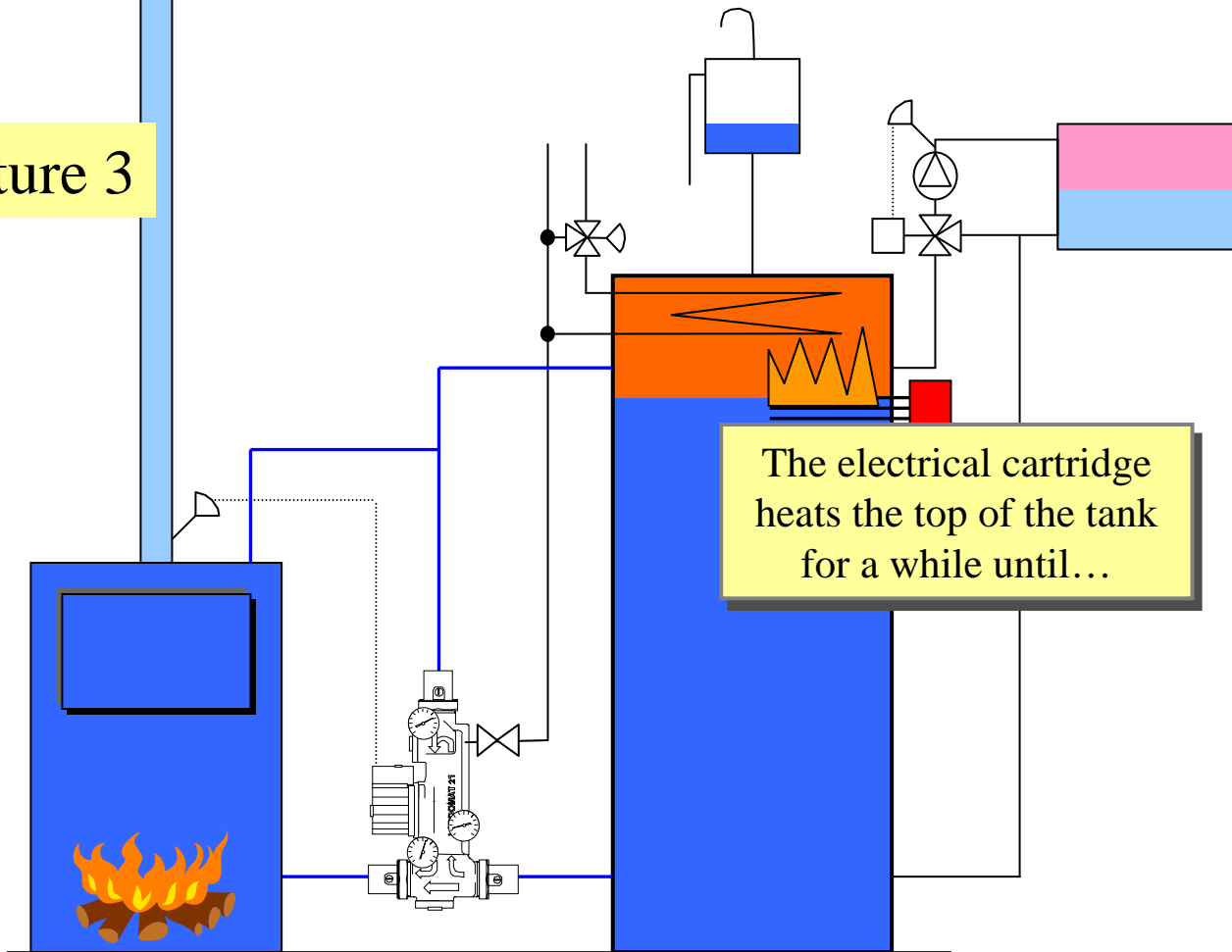

The electrical cartridge heats the top of the tank for a while until...

A fire is lit in the boiler...



Termoventiler AB

Laddomat 21



Picture 4

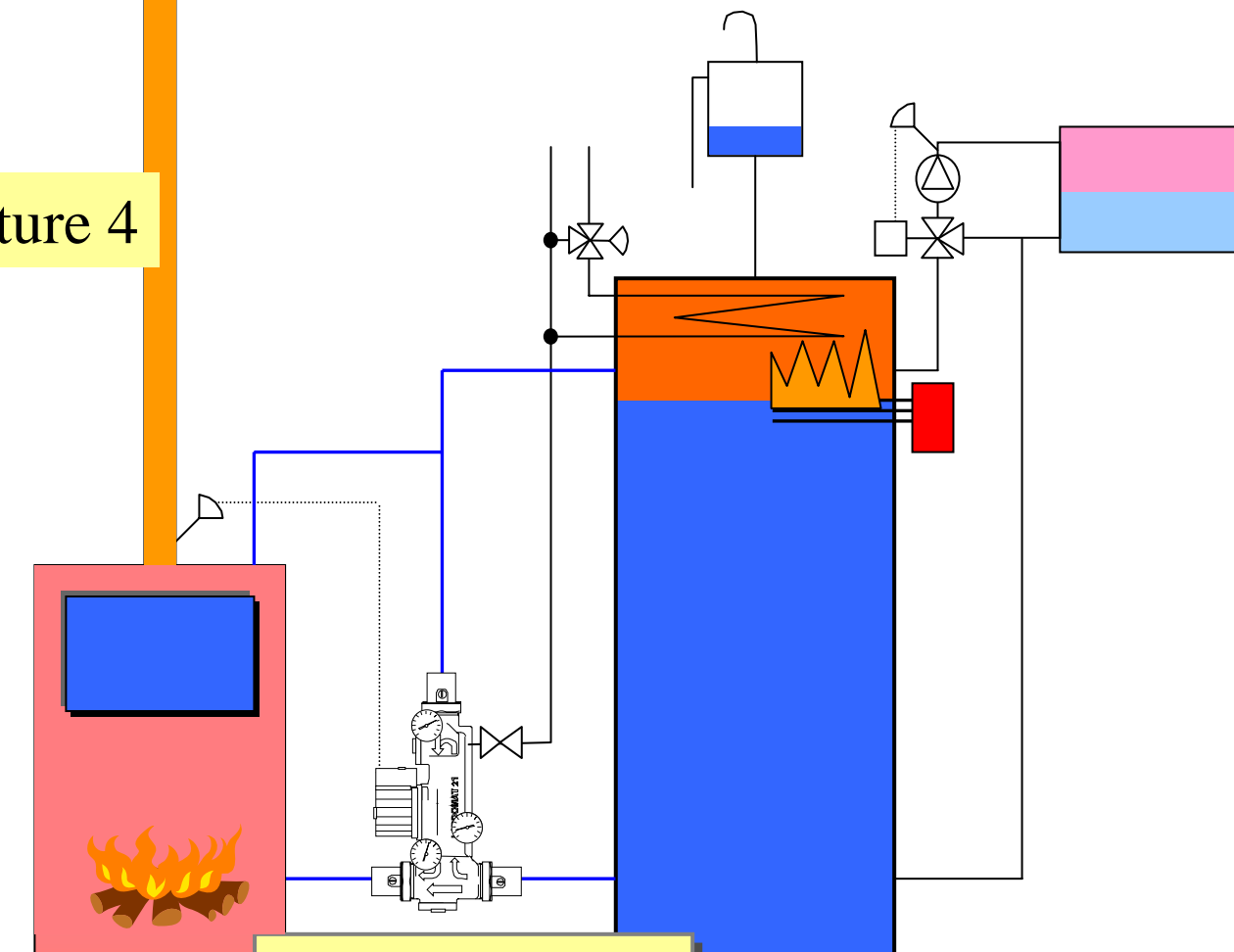

...the temperature increases in the boiler



Termoventiler AB

Laddomat 21

Picture 5

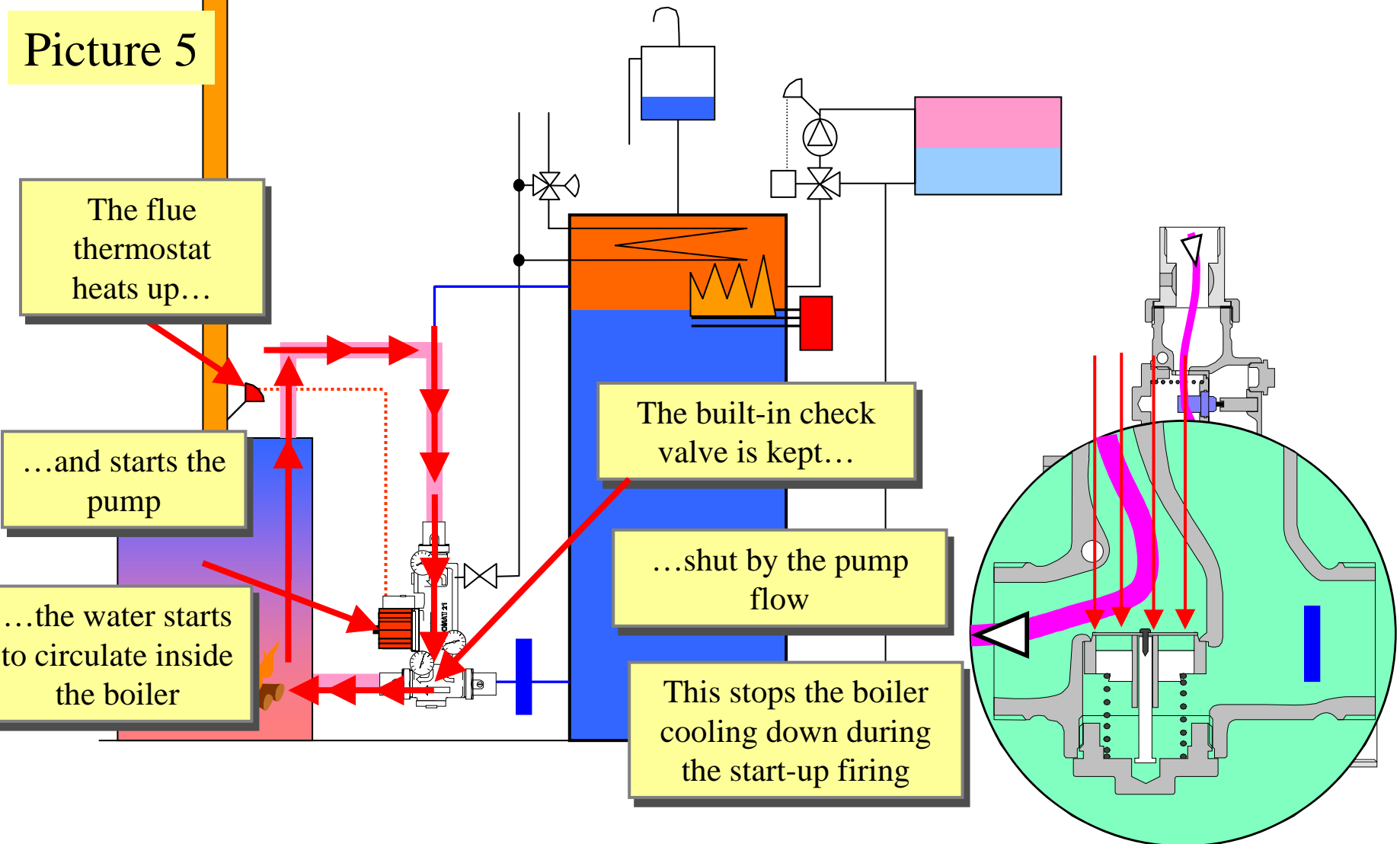

The flue thermostat heats up...

...and starts the pump

...the water starts to circulate inside the boiler

The built-in check valve is kept...

...shut by the pump flow

This stops the boiler cooling down during the start-up firing

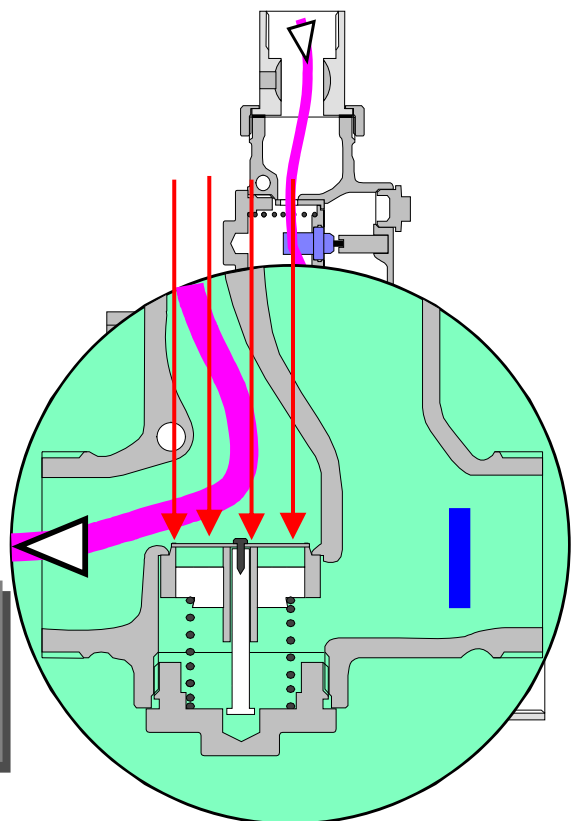



Termoventiler AB



Laddomat 21

Picture 6

...the tank is being charged with hot water

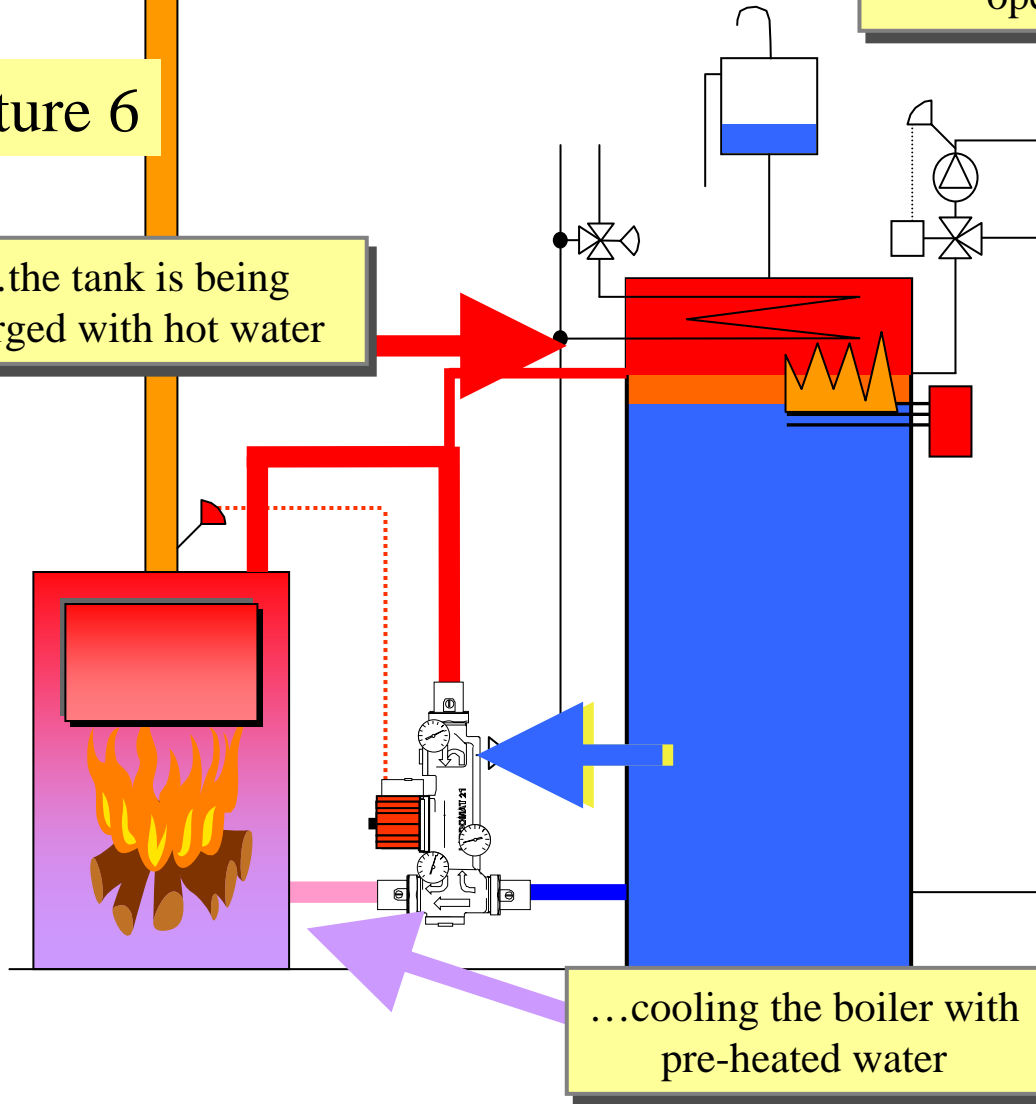

...cooling the boiler with pre-heated water

At +78°C, the thermal valve opens...

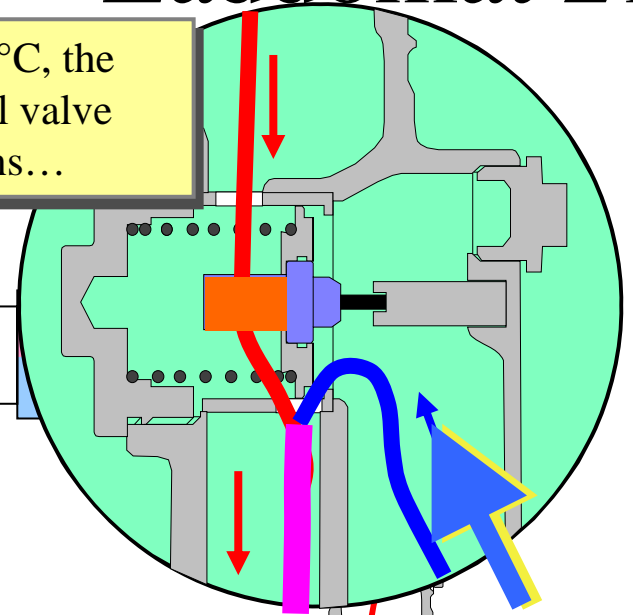

...and cold water from the tank is added

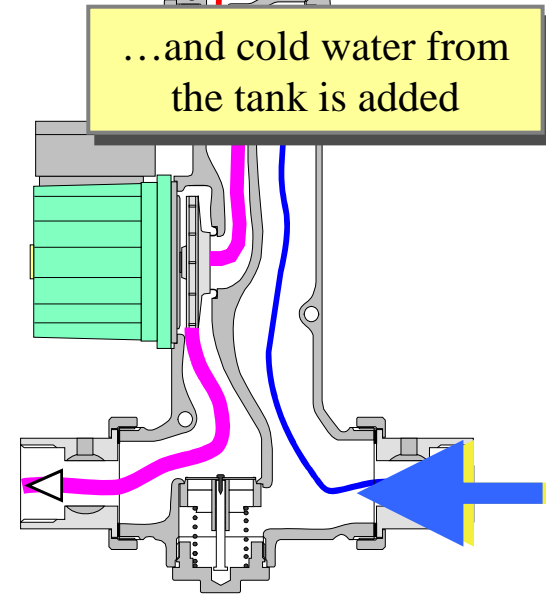

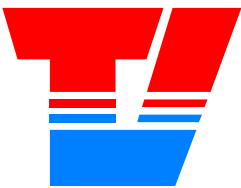

Termoventiler AB

Laddomat 21



Picture 7

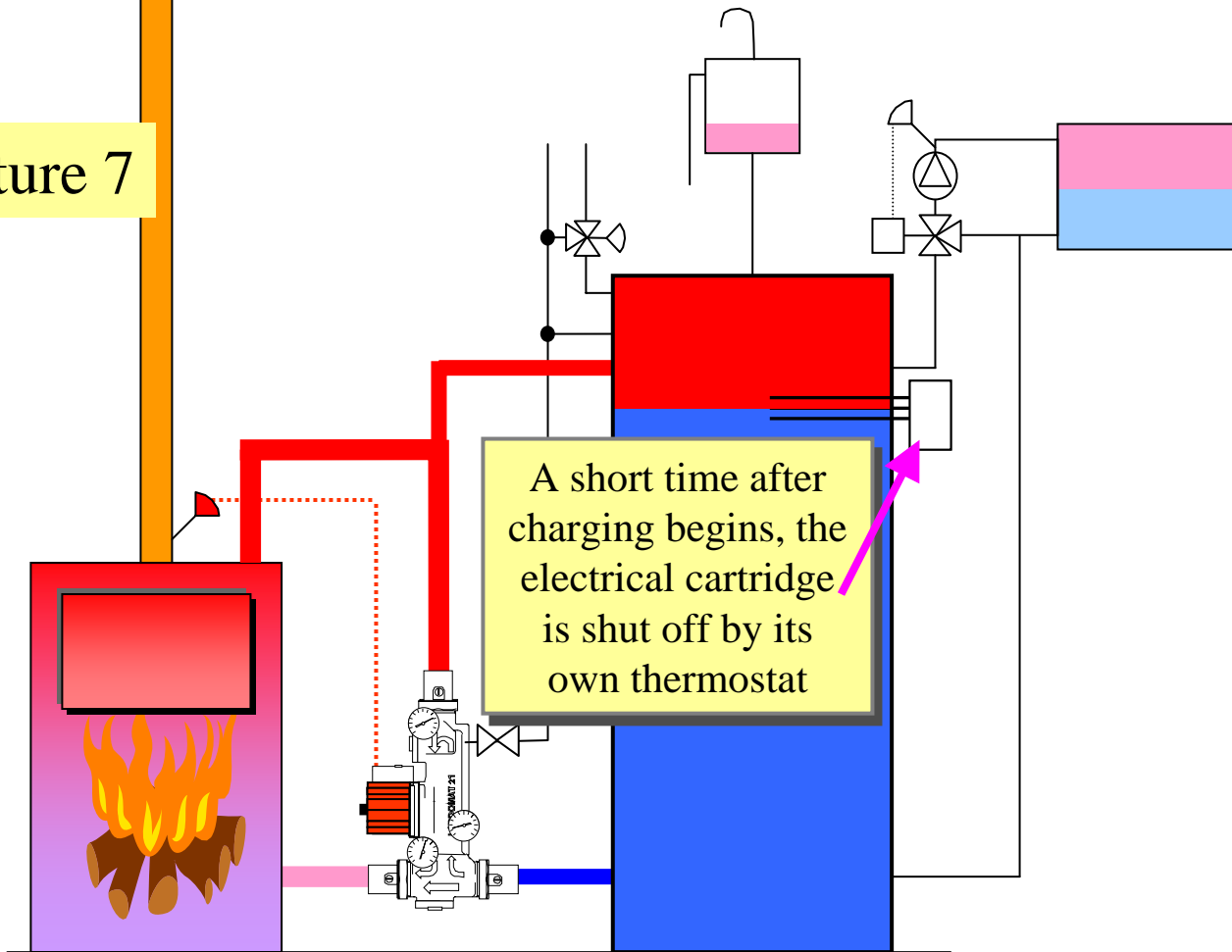

A short time after charging begins, the electrical cartridge is shut off by its own thermostat



Termoventiler AB

Laddomat 21

Picture 8

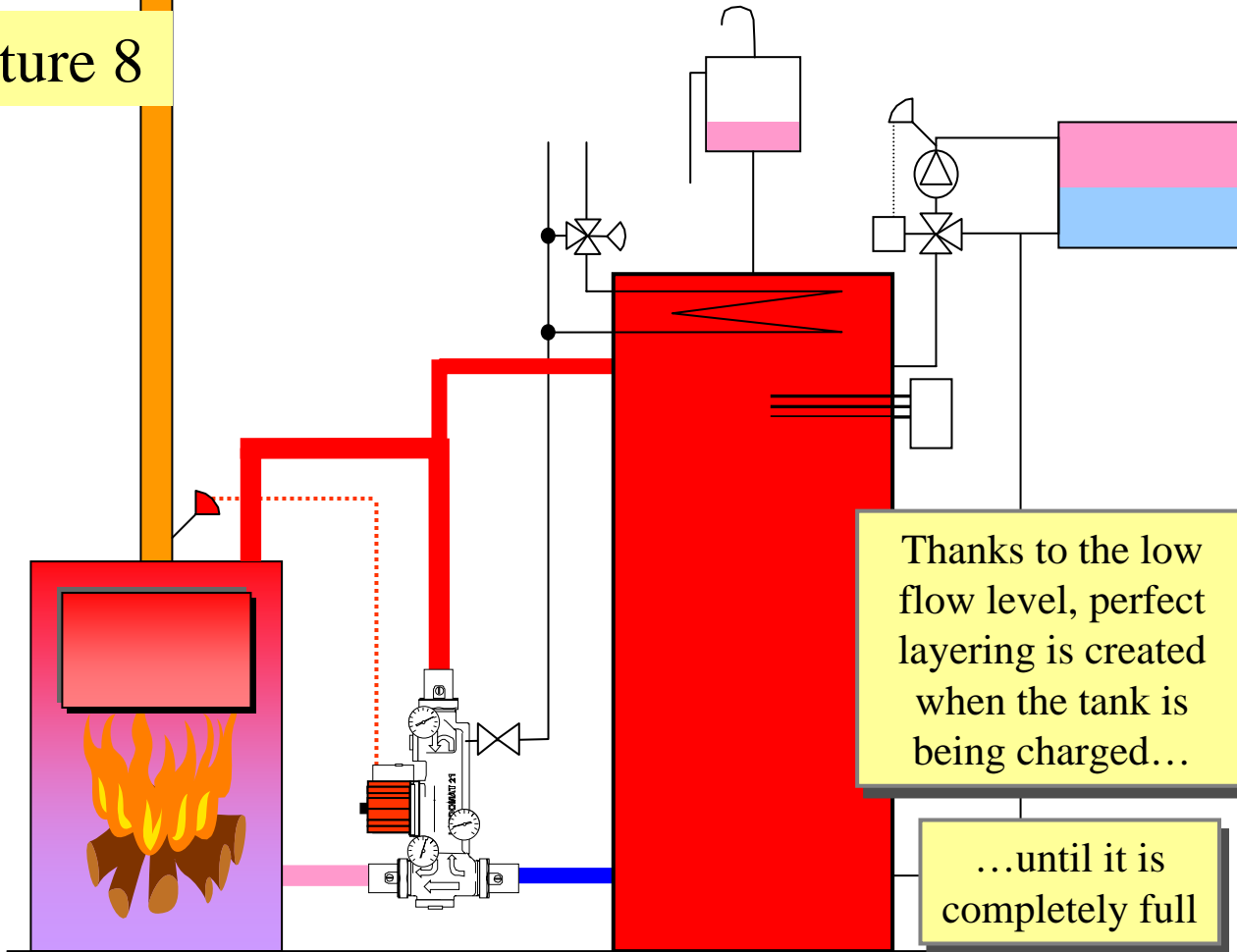



Termoventiler AB

Laddomat 21

Picture 9

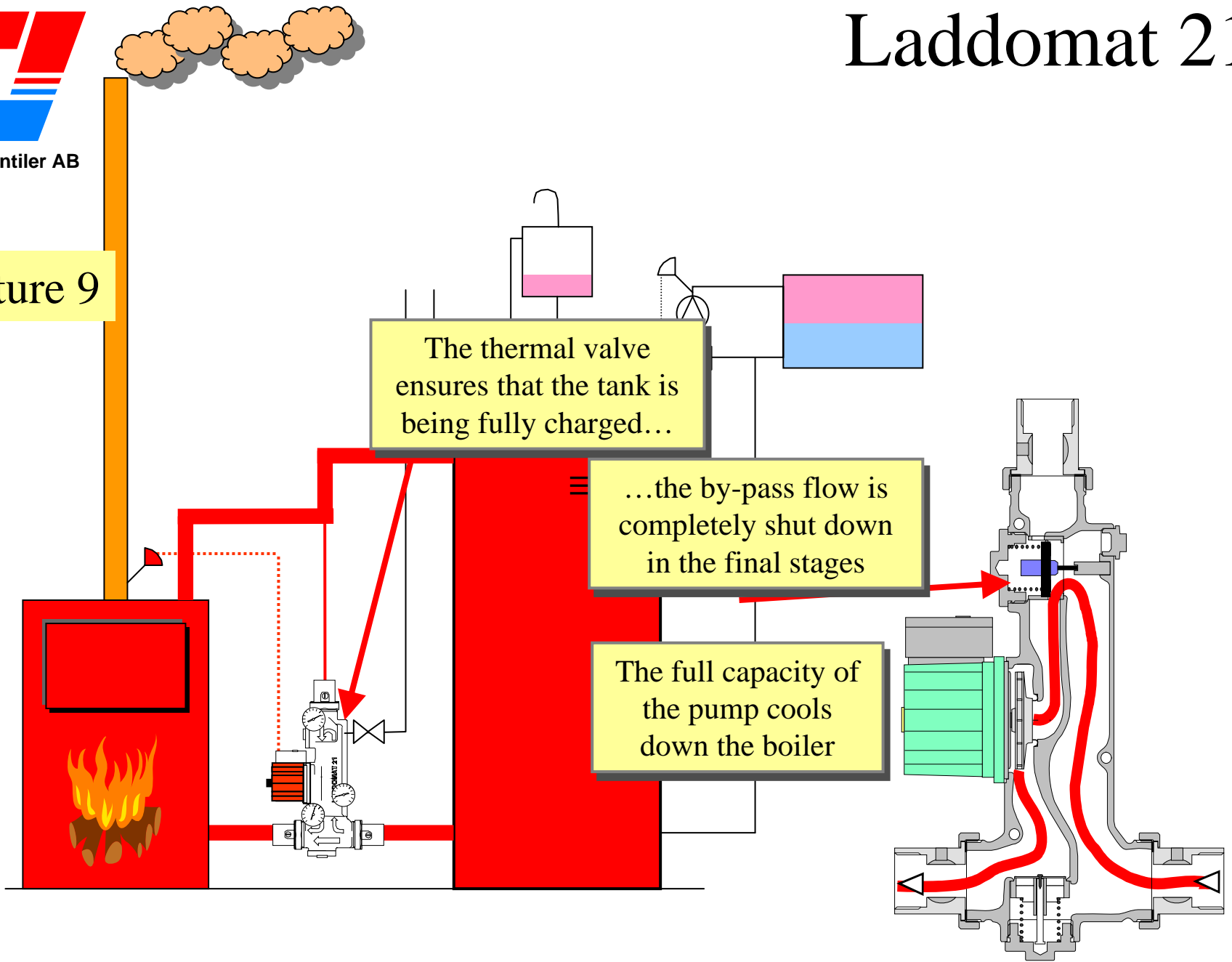

Laddomat 21

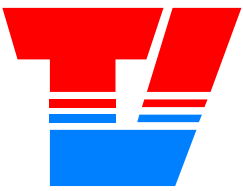

Termoventiler AB

Picture 10

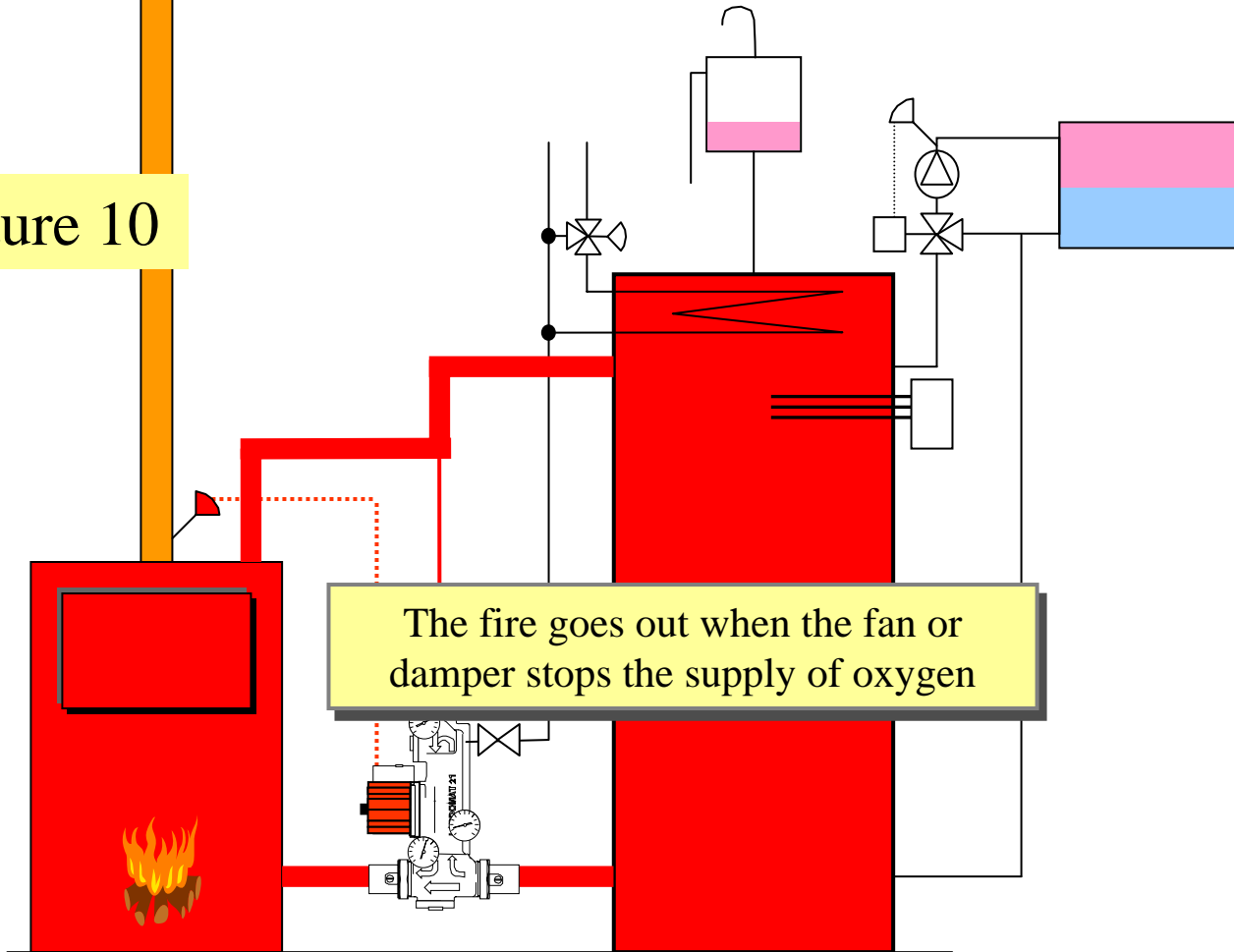

The fire goes out when the fan or damper stops the supply of oxygen

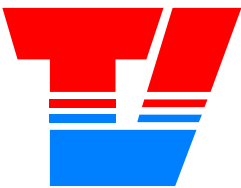

Termoventiler AB

Laddomat 21

Picture 11

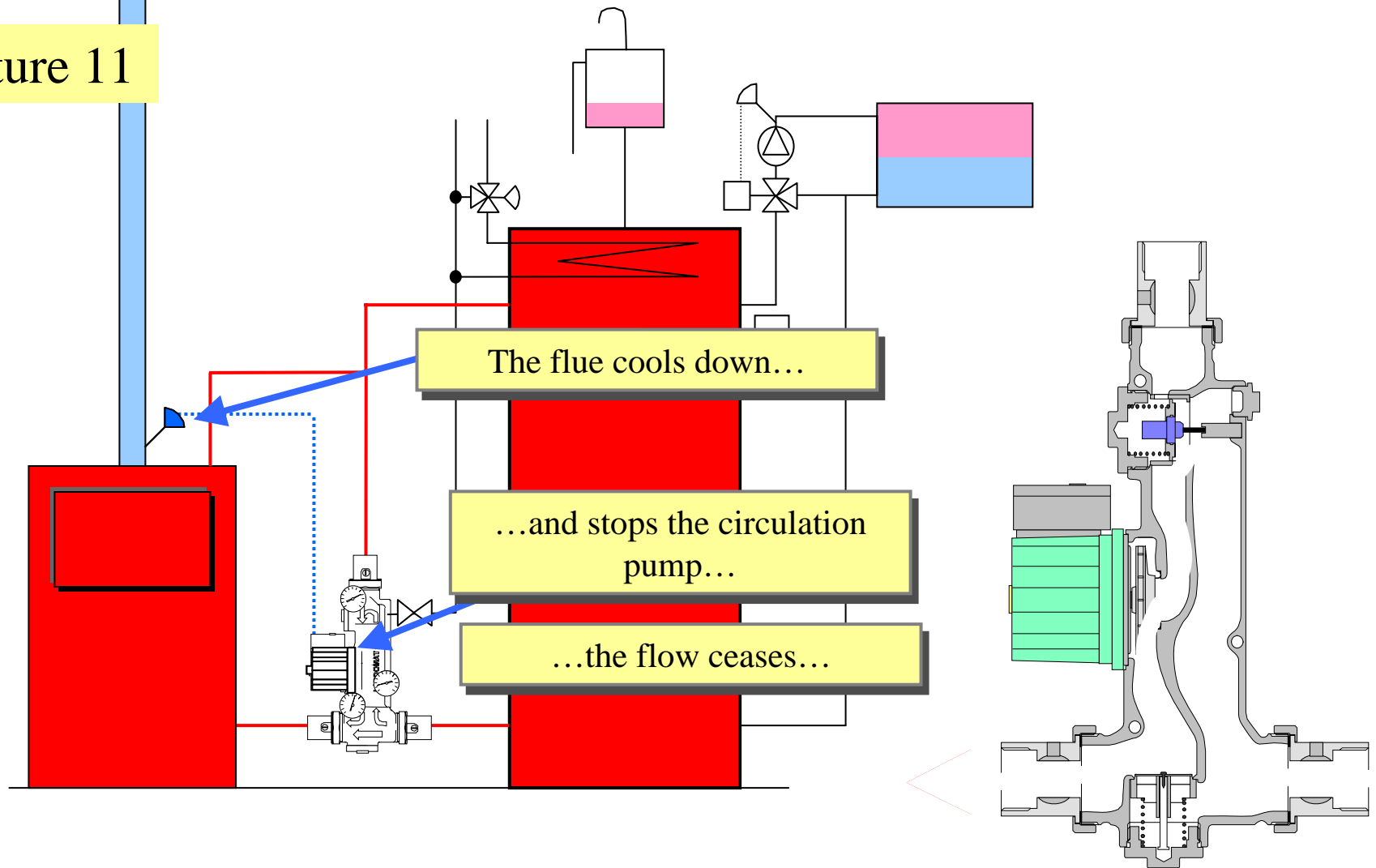



Termoventiler AB

Laddomat 21

Picture 12

Residual heat from the
voiler is transferred to the
top of the tank...

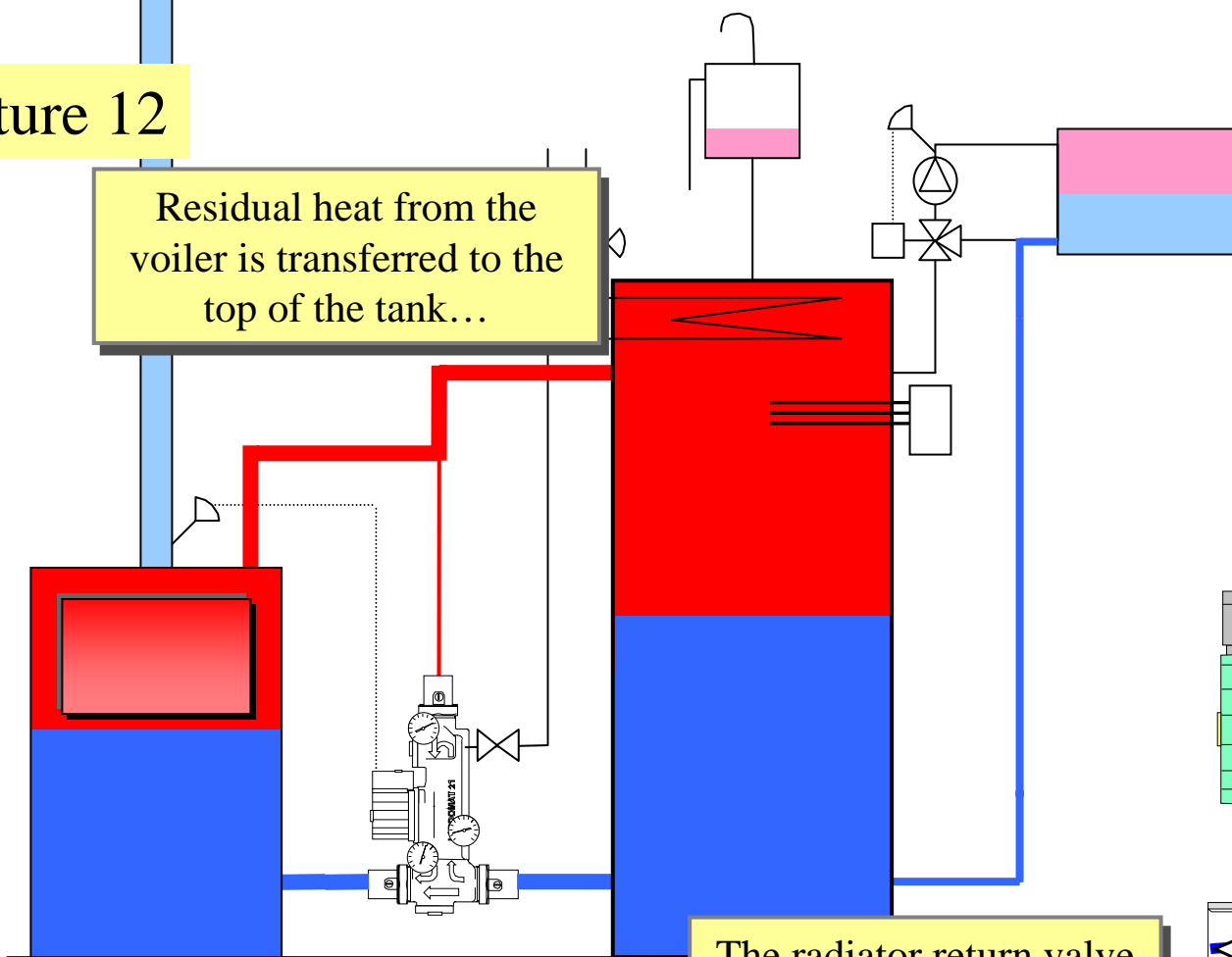

The radiator return valve
adds cold return water...

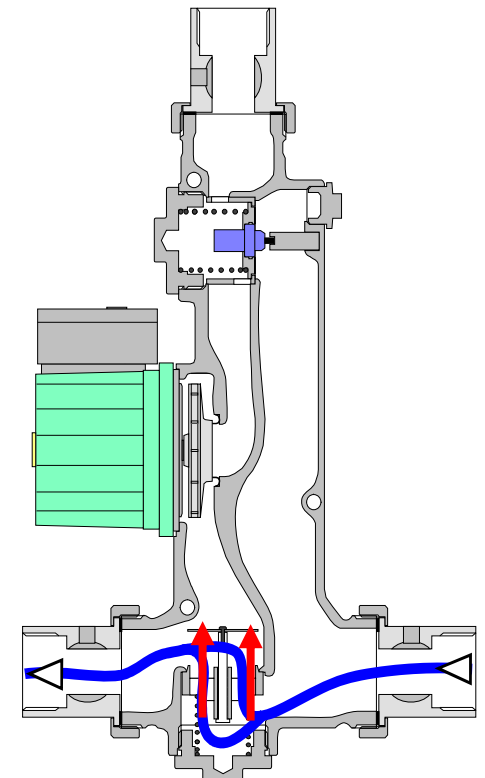

The check-valve opens



Termoventiler AB

Laddomat 21

Picture 13

After a number of hours,
there is no more heat in
the tank...

...and the electrical
cartridge starts up again

The radiator return valve
adds cold return water

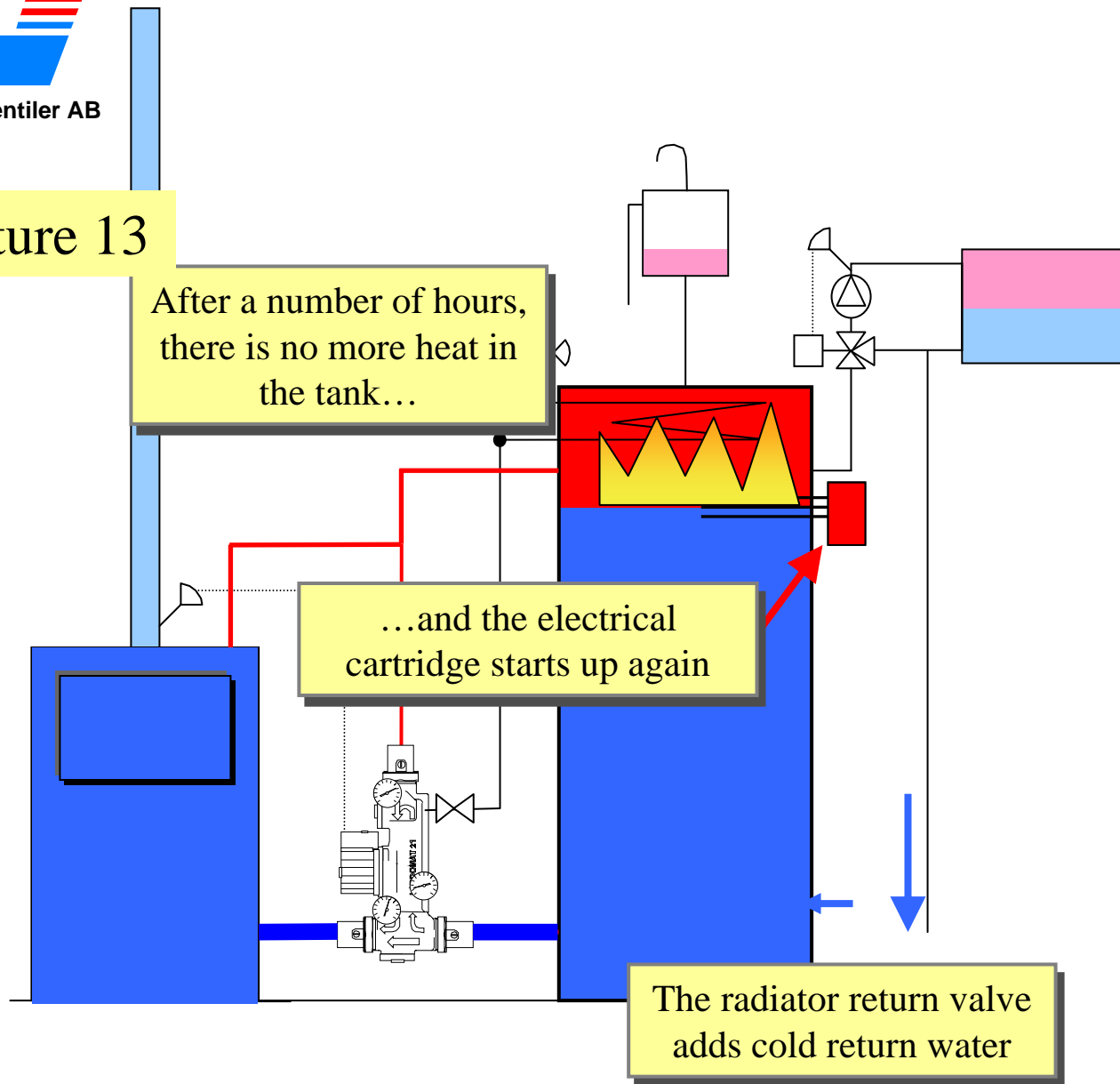



Termoventiler AB

Laddomat 21

This is how the Laddomat 21 works in the event of a power cut

Picture 14

The boiler is burning at maximum output

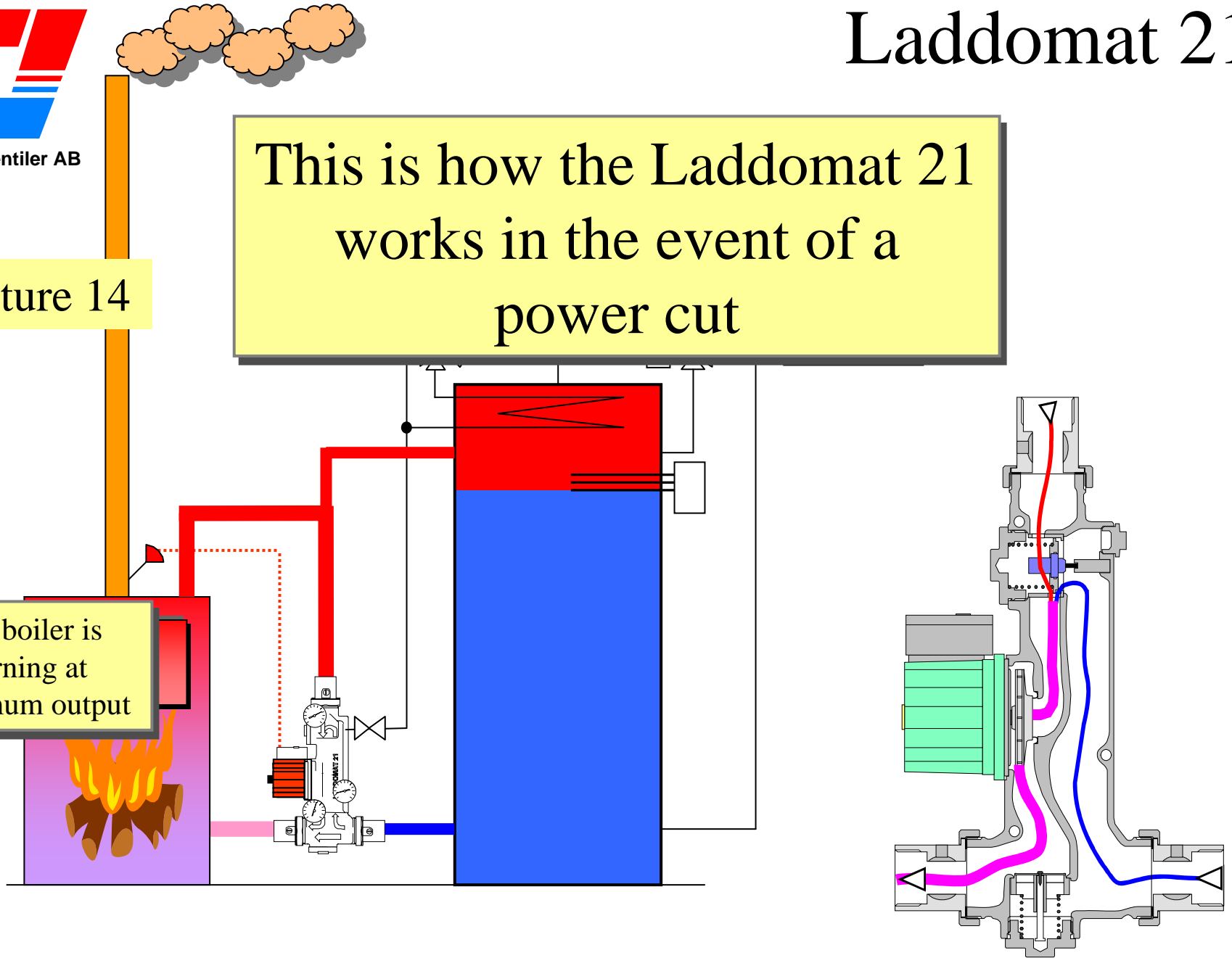

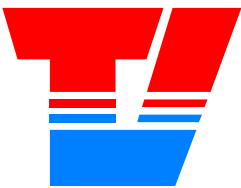

Termoventiler AB

Laddomat 21

This is how the Laddomat 21 works in the event of a power cut

Picture 15

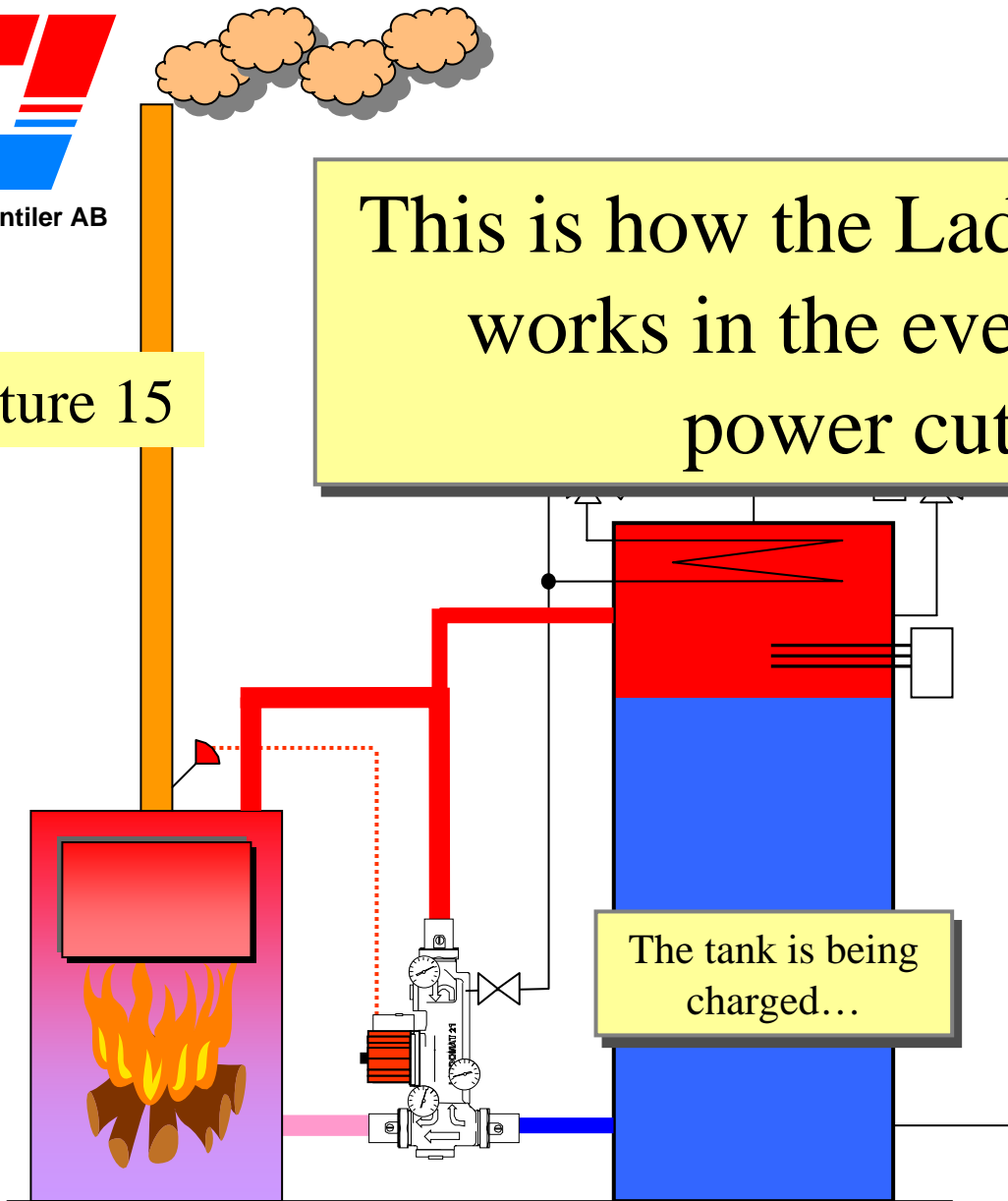



Termoventiler AB

Laddomat 21

Picture 16

This is how the Laddomat 21 works in the event of a power cut

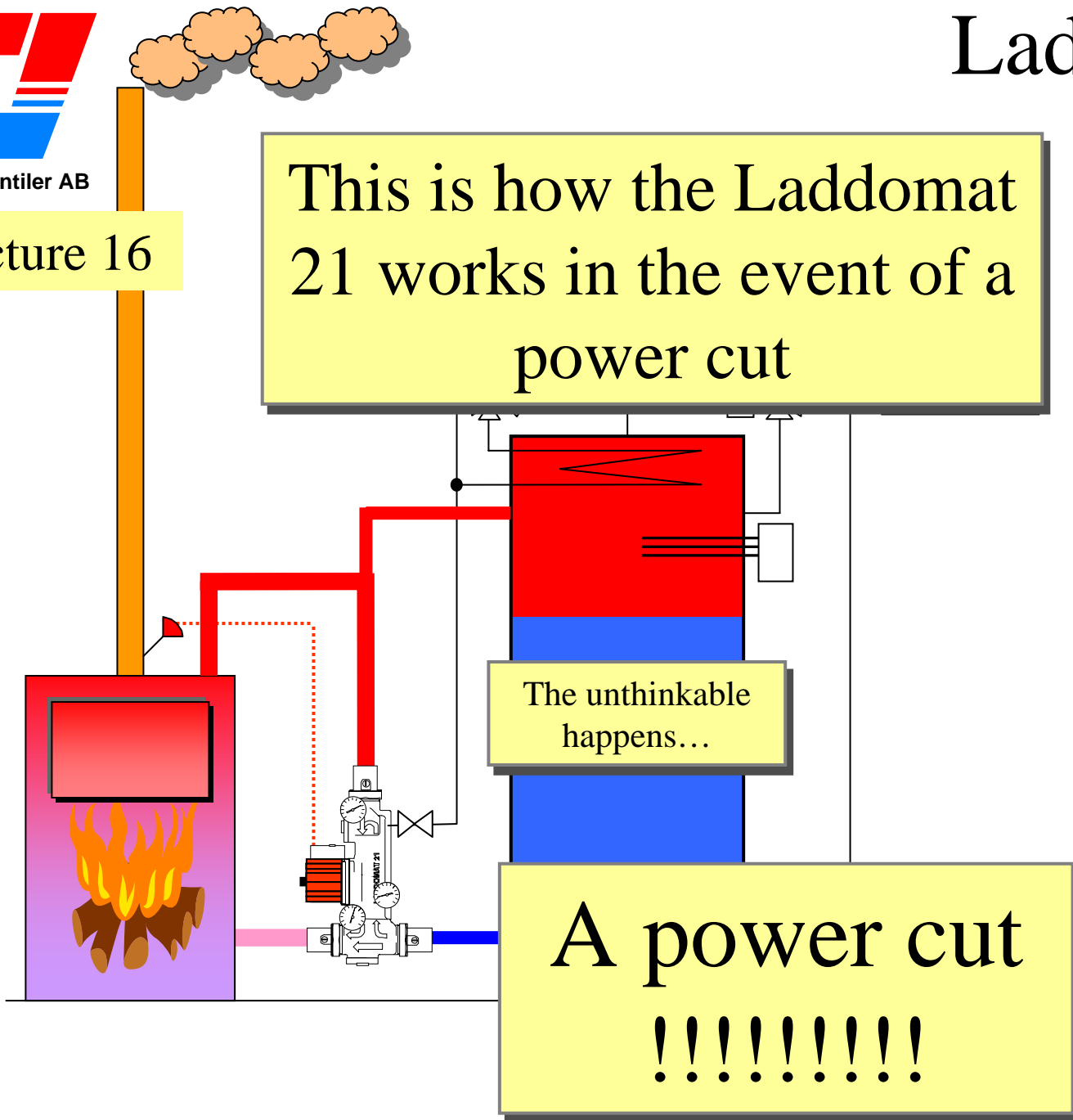

The unthinkable happens...

A power cut
!!!!!!!!!!!!



Termoventiler AB

Laddomat 21

Picture 17

This is how the Laddomat 21 works in the event of a power cut

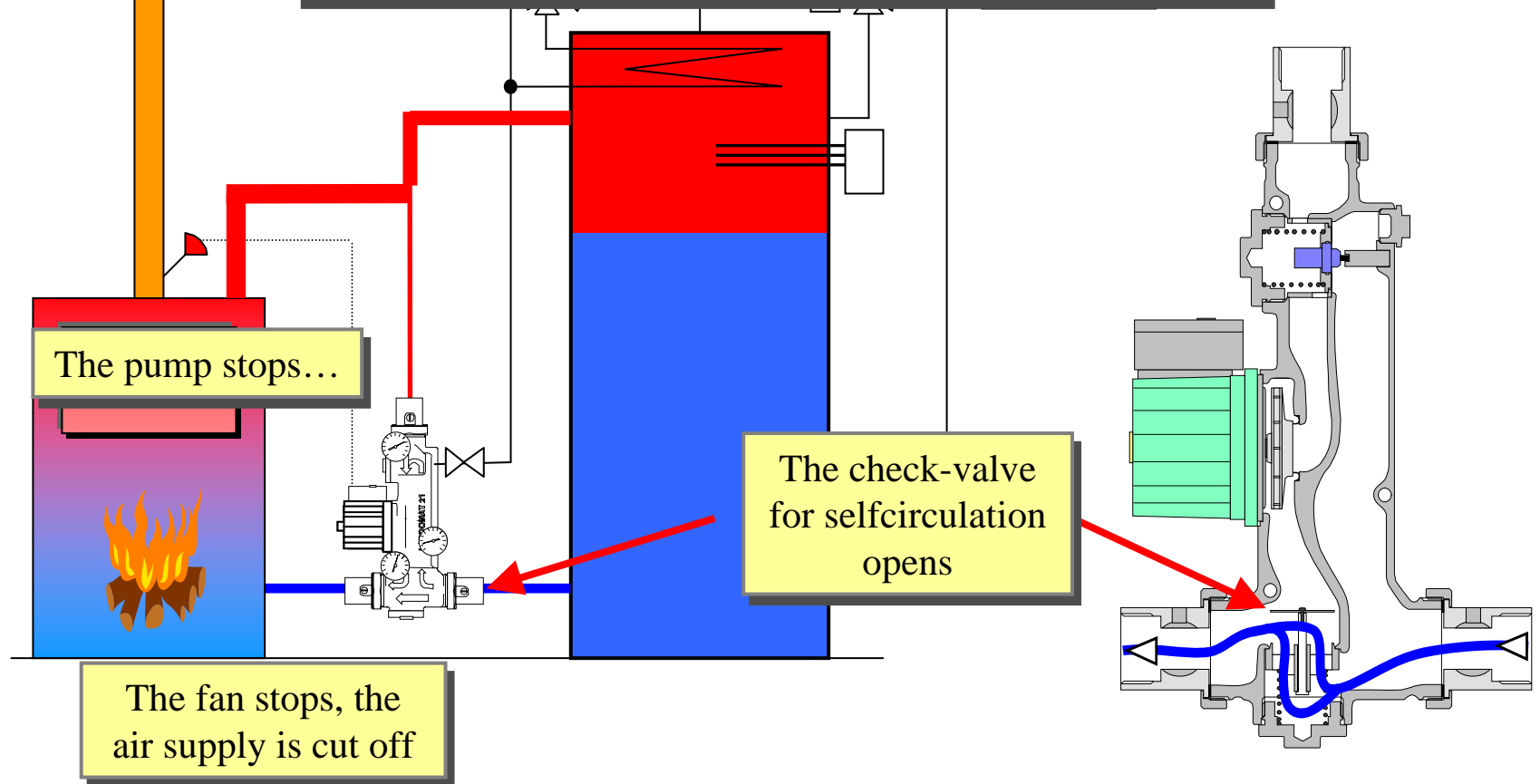

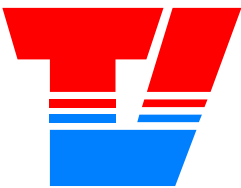

Termoventiler AB

Laddomat 21

Picture 18

This is how the Laddomat 21 works in the event of a power cut

The heat from the boiler is transferred to the tank.

The fire can be kept going at limited output until electrical power is restored.

The pressure of the natural circulation system fills the boiler with cold water.

